

M12 XTREME MALE 0° / M12 FEMALE 0°

PUR 4x0,5 black UL/CSA, drag ch 1.5m

Xtreme - Outdoor

Stainless steel 1.4305 (V2A)

Male straight – female straight

M12 – M12, 4-pole

Art-No. 7005 - M12 Lite - (plastic hexagonal screw) on request

Plastic housings with good resistance against chemicals and oils.

The resistance to aggressive media should be individually tested for your application. Further details on request.

Further cable lengths on request.

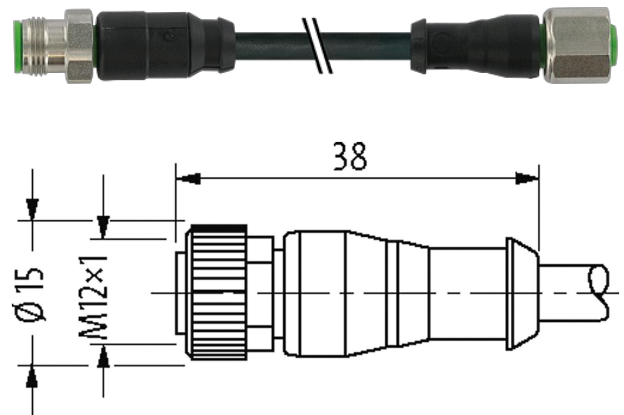
[Link to Product](#)**Illustration**

Product may differ from Image

Form

Form 40021

General data

Standards DIN EN 61076-2-101 (M12)

Mounting method inserted, tightened

Pollution Degree 3

CablesNo./diameter of wires 4 x 0.5 mm²

Wire isolation PP (br, wh, bl, bk)

C-track properties 10 Mio.

Material (jacket) PUR (UL/CSA)

Outer Ø 4.9 mm ±5%

Bend radius (moving) 10 x outer Ø

Temperature range (fixed) -40...+80 °C

Temperature range (mobile) -25...+80 °C

Cable identification 737

Cable Type 3 (PUR)

Approval (cable) cURus (AWM-Style 20549/10493); CE conform

Cable weight [g/m] 44,00

Material (wire) Cu wire, bare

Resistor (core) max. 39 Ω/km (20 °C)

Single wire Ø (core)	0.19 mm
Construction (core)	28× 0.15 mm (multi-strand wire class 6)
Diameter (core)	4× 0.5 mm ²
AWG	similar to AWG 20
Material (wire isolation)	PP
Material property (wire isolation)	CFC-, halogen-, cadmium-, silicone- and lead-free
Shore hardness (wire isolation)	70 ±5 D
Wire-Ø incl. isolation	1.4 mm ±5%
Color/numbering of wires	br, bk, bl, wh
Stranding combination	4 wires twisted
Shield	no
Material (jacket)	PUR
Material property (jacket)	CFC-, halogen-, cadmium-, silicone- and lead-free, matt, low-adhesion, machine easy to process, abrasion-resistant, hydrolysis and microbial resistant
Shore hardness (jacket)	90 ±5 A
Outer-Ø (jacket)	4.9 mm ±5%
Color (jacket)	black
chemical resistance	good resistance to oil, gasoline and chemicals (EN 60811-404)
thermal resistance	flame retardant UL 1581 VW1 / CSA FT1 / IEC 60332-1, IEC 60332-2-2
Nominal voltage	300 V AC
Test voltage	2500 V AC
Current load capacity	to DIN VDE 0298-4
Temperature range (fixed)	-40...+80 °C, (+90 °C at max. 10 000 operating hours)
Temperature range (mobile)	-25...+80 °C, (+90 °C at max. 10 000 operating hours)
Bend radius (fixed)	5× outer Ø
Bend radius (moving)	10× outer Ø
No. of bending cycles (C-track)	max. 10 Mio. (25 °C)
Travel speed (C-track)	max. 3 m/s
Acceleration (C-track)	max. 10 m/s ²
Torsion stress	±180°/m
No. of torsion cycles	max. 2 Mio. (25 °C)
Torsion speed	35 cycles/min
Jacket Color	black

Technical Data

Operating voltage	max. 250 V AC/DC
Rated surge voltage	2.5 kV
Operating current per contact	max. 4 A
No. of poles	4-pole
Configuration	fully used
Material group	IEC 60664-1, category I
Coding	A-coded
LED display	no
Locking of ports	Screw thread (M12×1 mm) recommended torque 0.6 Nm, self-securing
Compression gland	M12 (SW14)
Protection	IP65, IP66K, IP67, IP68 inserted and tightened (EN 60529)
Material	PUR
Locking material	Stainless steel 1.4305 (V2A)
suitable for corrugated tube (internal Ø)	10 mm

Commercial data

country of origin	DE
customs tariff number	85444290
EAN	4048879305297
eClass	27279218
Packaging unit	1

Sketch

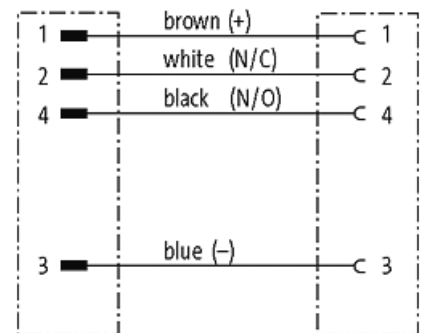
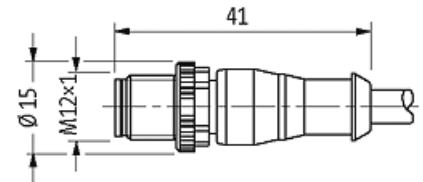

Male

Female

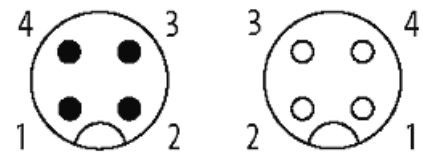

Product may differ from Image